

CGAM-200-EW Antimicrobial End Wall Guard

- .063-inch aluminum with antimicrobial powder coat finish
- Recessed mounting flanges
- 2-inch wing size
- 1/8-inch corner radius
- Custom-fabricated per field measurements
- Full range of RAL colors available
- Custom lengths, angles, and wing sizes available
- Other thicknesses available

Standard Lengths

- 48-inch
- 96-inch
- 120-inch

Mounting Options

- Mechanical fasteners (supplied by others)
- Pre-drilled mounting holes available

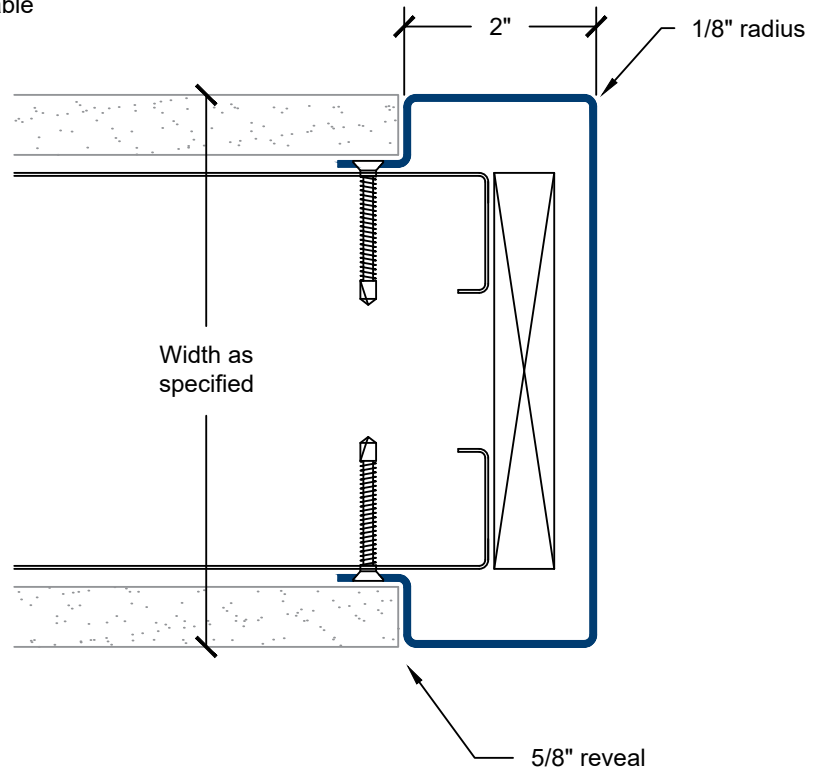
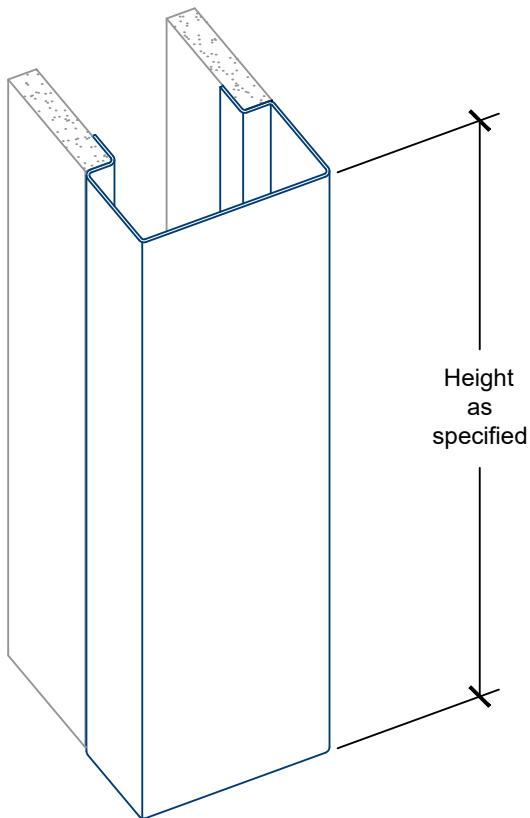

Spacing for pre-drilled countersunk holes

- 3-inches from ends
- Spaced equally not to exceed 36-inches