

CGP-300-EW Patterned Stainless Steel End Wall Guard

- Type 304 #4 satin finish patterned stainless steel
- Recessed mounting flanges
- 3-inch wing size
- 1/8-inch corner radius
- Custom-fabricated per field measurements
- Manufacturer's standard patterns
- Custom lengths, angles, and wing sizes available
- Other stainless steel grades and finishes available

Standard Lengths

- 48-inch
- 96-inch
- 120-inch

Mounting Options

- Mechanical fasteners (supplied by others)
- Pre-drilled mounting holes available

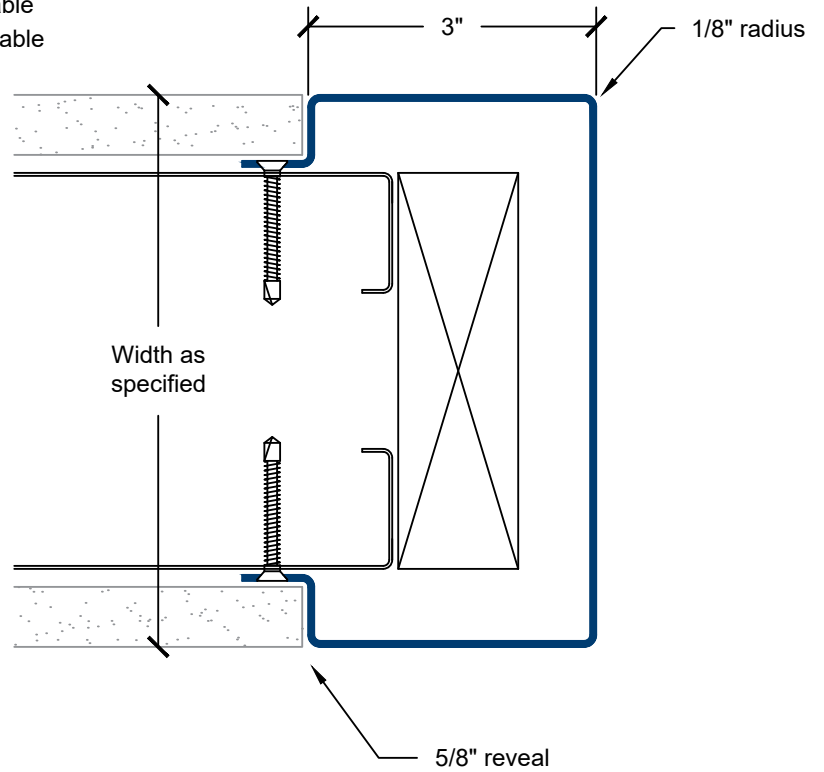
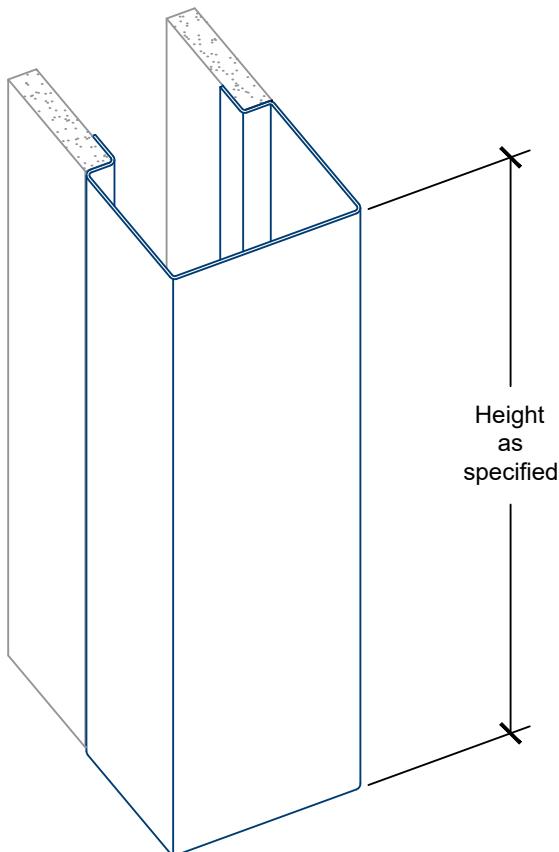

Spacing for pre-drilled countersunk holes

- 3-inches from ends
- Spaced equally not to exceed 36-inches