

CGD-300-EW Decorative Aluminum End Wall Guard

- .080-inch grade 5052 aluminum with wood grain powder coat finish
- Recessed mounting flanges
- 3-inch wing size
- 1/8-inch corner radius
- Custom-fabricated per field measurements
- Custom lengths, angles, and wing sizes available
- Other finishes and thicknesses available

Standard Lengths

- 48-inch
- 96-inch (max)

Mounting Options

- Mechanical fasteners (supplied by others)
- Pre-drilled mounting holes available

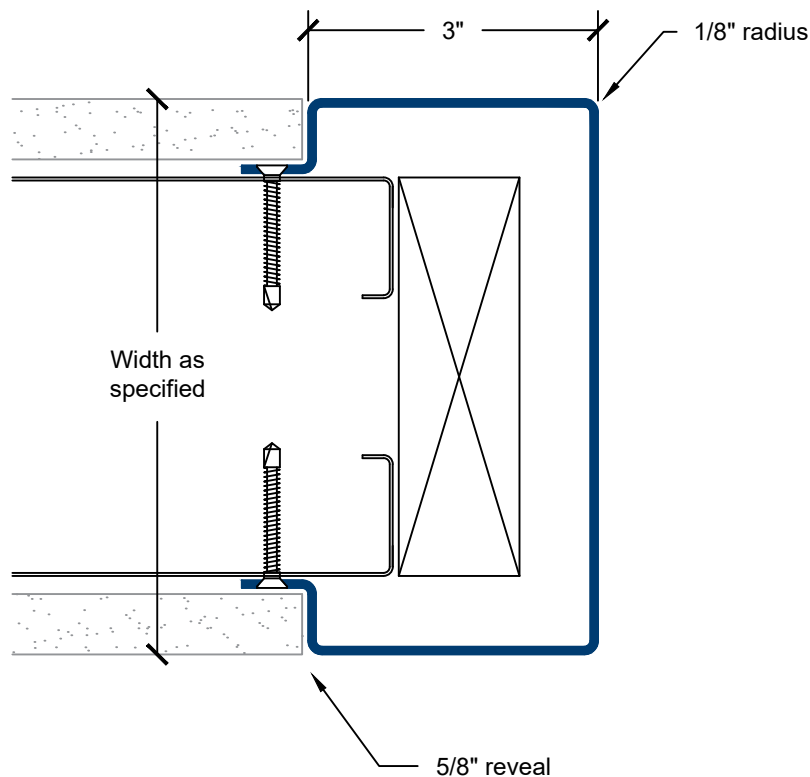
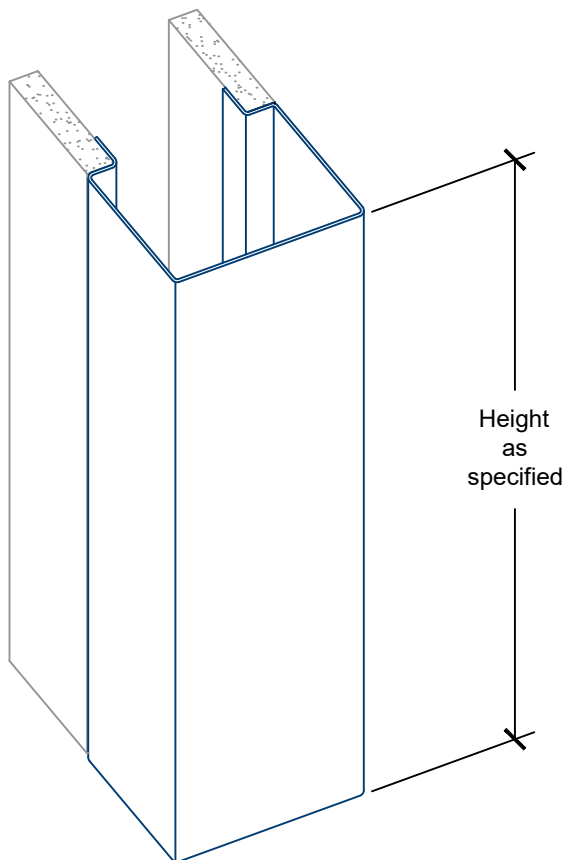

Spacing for pre-drilled countersunk holes

- 3-inches from ends
- Spaced equally not to exceed 36-inches