

CRS-4SSW Welded Stainless Steel Crash Rail

- Type 304 #4 satin finish stainless steel
- Continuous wood retainer
- Supplied in custom lengths with seamless welded ends
- Custom sizes available
- Other stainless steel grades and finishes available

Mounting Options

- Mechanical fasteners (supplied by others)

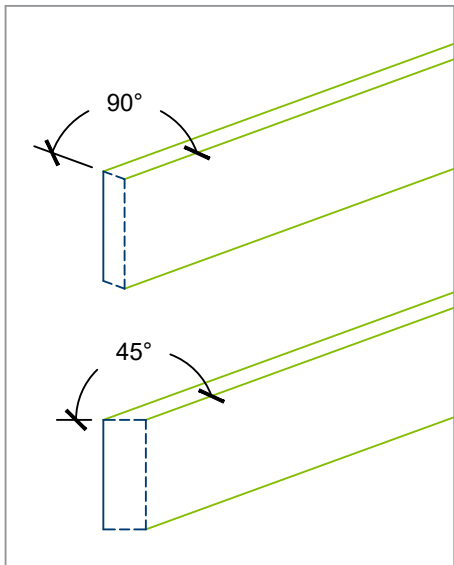

Seamless welded ends
(straight or angled)

