

CG-402-EW Aluminum End Wall Guard

- .080-inch grade 5052 mill finish aluminum
- 3-inch wing size
- 1/8-inch corner radius
- Custom-fabricated per field measurements
- Custom lengths, angles, and wing sizes available
- Other aluminum grades, finishes, and thicknesses available

Standard Lengths

- 48-inch
- 96-inch
- 120-inch

Mounting Options

- ADH-50 adhesive
- Mechanical fasteners (supplied by others)
- Pre-drilled mounting holes available

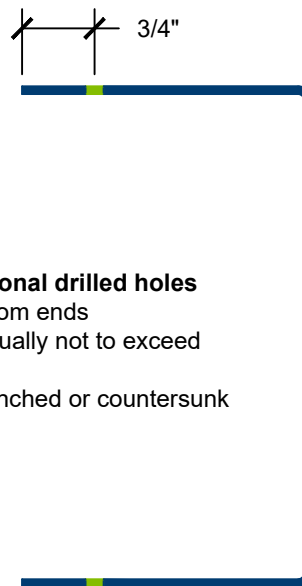
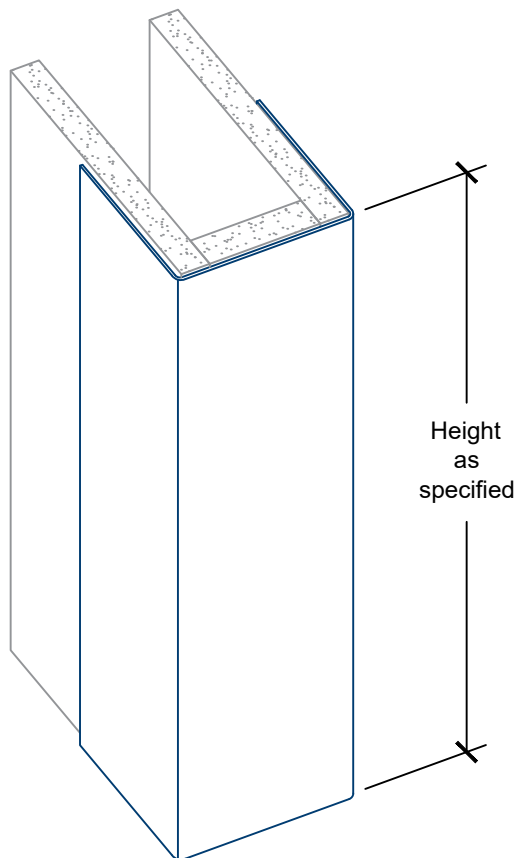
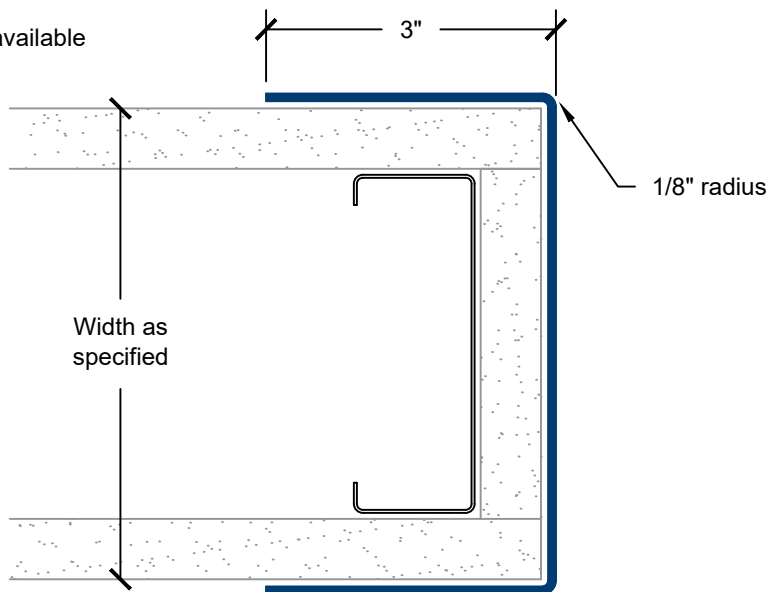

Spacing for optional drilled holes

- 3-inches from ends
- Spaced equally not to exceed 36-inches
- Specify punched or countersunk holes