

CGC-50 Colored Stainless Steel Corner Guard

- Type 304 colored stainless steel
- 3 1/2-inch wing size
- 1/8-inch corner radius
- 90-degree angle
- Manufacturer's standard colors
- Custom lengths, angles, and wing sizes available
- Other stainless steel grades and finishes available

Standard Lengths

- 48-inch
- 96-inch
- 120-inch

Mounting Options

- ADH-50 adhesive
- Mechanical fasteners (supplied by others)
- Pre-drilled mounting holes available

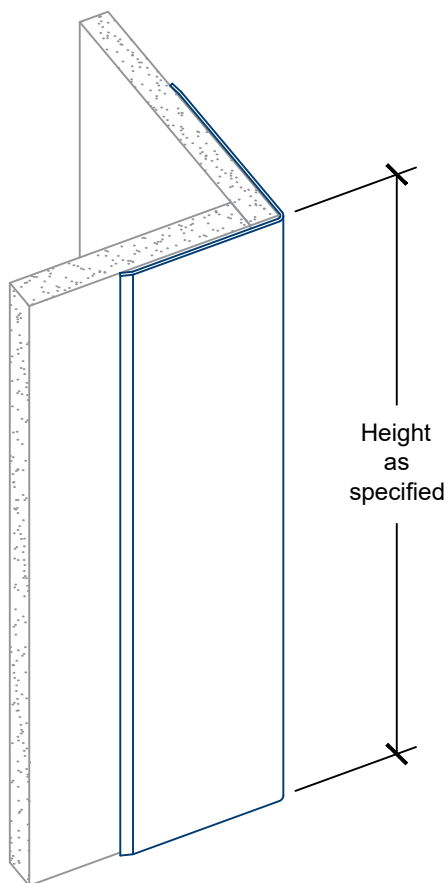
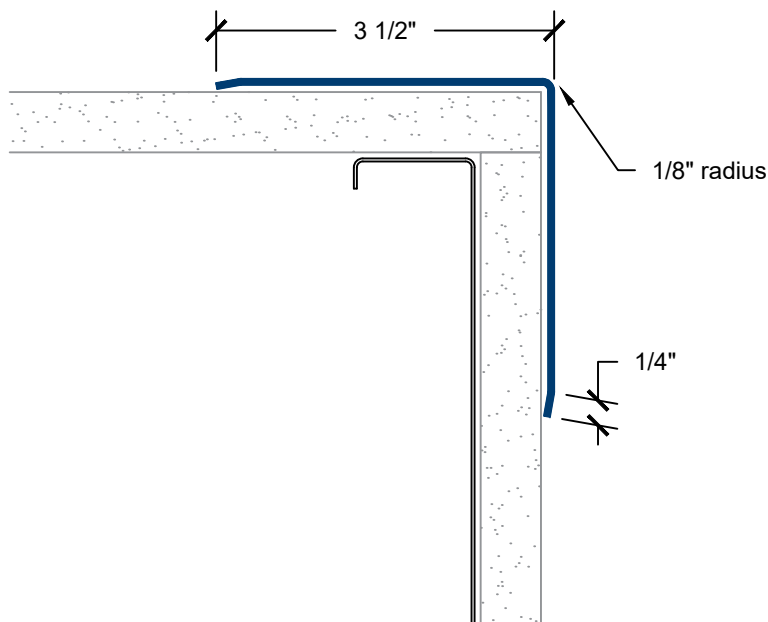

Spacing for optional drilled holes

- 3-inches from ends
- Spaced equally not to exceed 36-inches
- Specify punched or countersunk holes